



Art No. WZ0031

Digitaler Messschieber Digital Caliper

Features:

- Suitable for internal and external measurement
- Imperial or metric reading
- With LCD screen display
- Reset the zero point of the instrument
- Point is memorized even if the unit is switched off
- Adjustable via a friction thumb roller
- Power on/off button
- Lightweight and durable
- Supplied with carry case
- Supplied with LR44 (1.5V) battery

Specifications:

Measuring range	0-150mm/0-6 inches
Resolution	0.01mm/0.0005 inches
Accuracy	±0.02mm/0.001inches (<100mm)
	±0.03mm/0.001inches (>100-200mm)
	±0.04mm/0.0005 inches (>200-300mm)
Repeatability	0.01mm/0.0005 inches
Product Weight	0.16kg
Product Dimension	240 x 78 x 13mm

Diagrammatic Sketch of Structure:

1. Step measuring faces
2. Internal measuring jaws
3. LCD display
4. Locking screw
5. Data output
6. Thumb wheel
7. Battery cover
8. Slider



Art No. WZ0031

Digitaler Messschieber Digital Caliper

- 9. Beam
- 10. Depth measuring bar
- 11. External measuring jaws
- 12. inch/mm button
- 13. ZERO setting button
- 14. Power On/Off button
- 15. Battery (LR44 1.5V)

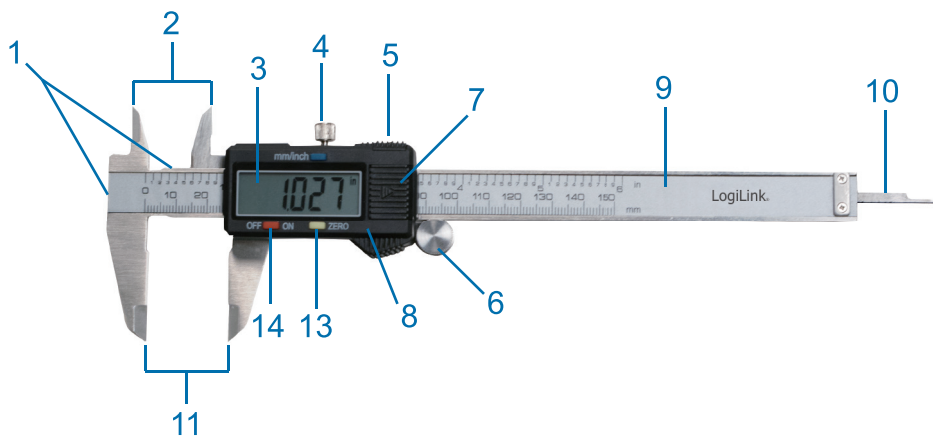

Measurement:

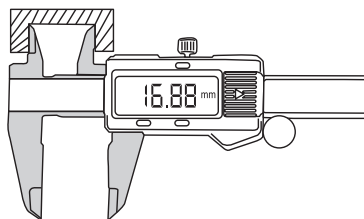

Measurement of Internal Dimensions.

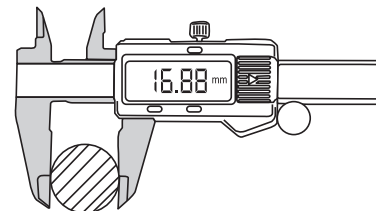

Measurement of External Dimensions.

* The specifications and pictures are subject to change without notice.
*All trade names referenced are the registered trademark of their respective owners.



Made in China



Art No. WZ0031

Digitaler Messschieber Digital Caliper

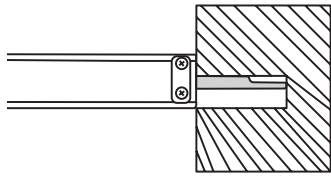

Measurement of Depth.

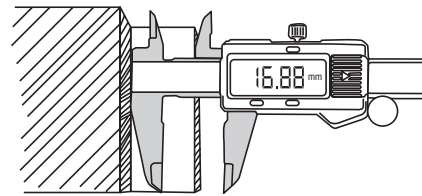

Measurement of Steps.

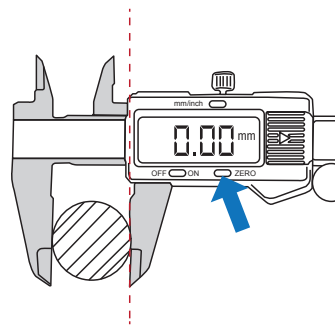
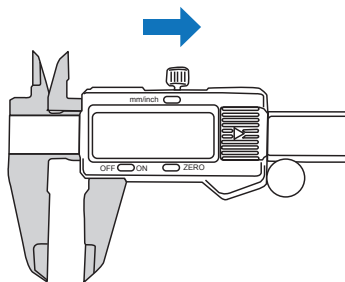

Differential method of measurement.
(application of zero setting at the desired position)

Package Contents:

- 1 x Digital Caliper
- 1 x Plastic Box
- 1 x User Manual
- 1 x LR44 battery

Packaging Information:

- Packing Dimension: 250 x 90 x 25mm
- Packing Weight: 0.3kg
- Carton Dimension: 500 x 280 x 300mm
- Carton Q'ty: 50pcs
- Carton Weight: 19kg

